

**DNA**

# **DNA Kotireititin WiFi 7 Pro**

**Home Router EE4600**

**Setting up the router as the  
primary router and as a WiFi extender**



This guide is made from  
100% recycled paper

# Contents

|   |           |
|---|-----------|
| <b>Contents of the package</b> .....  | <b>4</b>  |
| <b>Router ports</b> .....   | <b>5</b>  |
| <b>Watch a short video to make it easier to set up the primary router</b> ..... | <b>6</b>  |
| <b>Quick guide to setting up the primary router</b> .....                       | <b>8</b>  |
| 1. Choosing where to set up the router in the home.....                         | <b>10</b> |
| 2. Ethernet connections in the home's network cabinet .....                     | <b>12</b> |
| 3. Connecting and turning on the router.....                                    | <b>14</b> |
| 4 a. Connecting home devices wirelessly (WiFi).....                             | <b>16</b> |
| 4 b. Connecting home devices with an Ethernet cable (LAN).....                  | <b>17</b> |
| <b>Changing the name and passwords of the WiFi network</b> .....                | <b>18</b> |
| <b>Extending WiFi coverage in the home when needed</b> .....                    | <b>20</b> |
| <b>Watch a short video to make it easier to set up the WiFi extender</b> .....  | <b>22</b> |
| <b>Quick guide to setting up the WiFi extender</b> .....                        | <b>24</b> |
| 1. Connecting and turning on the extender.....                                  | <b>26</b> |
| 2.1. Pairing devices .....  | <b>28</b> |
| 2.2. Checking the pairing connection.....                                       | <b>30</b> |
| 3. Choosing where to set up the extender in the home .....                      | <b>32</b> |
| <b>Indicator lights explained</b> .....   | <b>34</b> |

## Contents of the package

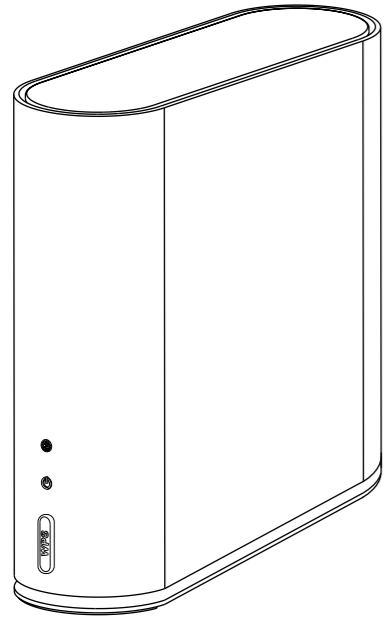

Power supply

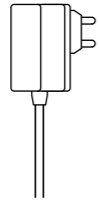

2 Ethernet

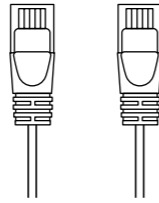

cables



Setup instructions



Safety instructions



Information card containing the WiFi network name and password

## Router ports

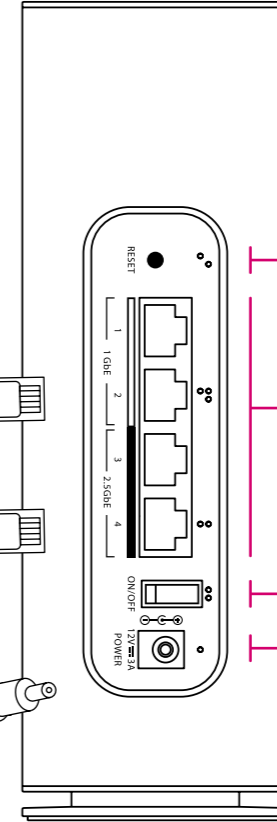
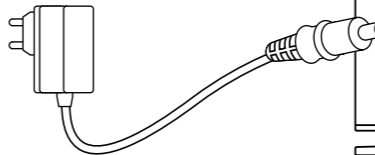
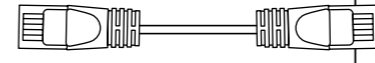
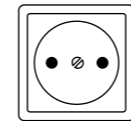
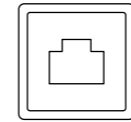
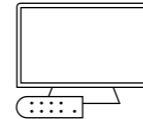

### Reset button

To restore factory settings, press the reset button for five seconds using a thin pin (e.g. an earring or a paper clip).

### Ethernet ports

2 x 1 Gbit/s ports and 2 x 2.5 Gbit/s ports. The device automatically detects your internet connection (WAN and LAN) when you connect the Ethernet cable.

### Power On/Off button

### Power socket

The power cord included with the device is connected to the power socket.

## Watch a short **video** to make it easier to set up the primary router

For video tutorials, guidance on how to manage your device settings and updated setup instructions based on user feedback, visit [dna.fi/tuki-reitittimet](https://dna.fi/tuki-reitittimet) or scan the QR code on the following page using your phone's QR code scanner (camera).

Video



Scan the code and go to the support page to watch the video tutorial on how to set up your device.

# Quick guide to setting up the **primary router**

## 1. Choosing where to set up the router in the home

Check the Ethernet socket labels in the room where you want to set up the router.

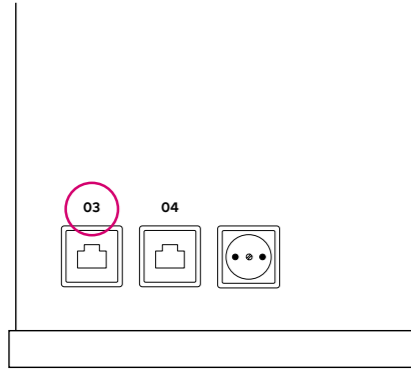

## 2. Ethernet connections in the home's network cabinet

Connect the Ethernet cable correctly in your network cabinet.

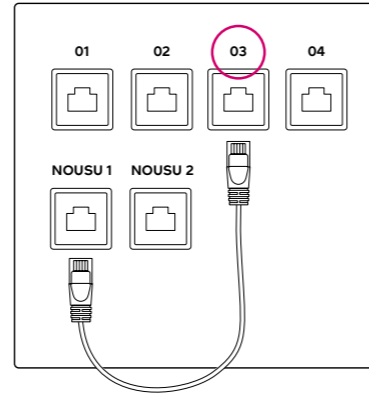

The internet connection can also come from another device, such as an outdoor modem power supply or a fibre media converter, instead of a network cabinet and an internet socket. For more information, see [dna.fi/tuki](http://dna.fi/tuki).

## 3. Connecting and turning on the router

Connect the Ethernet cable at one end to the internet socket in the room and at the other end to the router. Plug in the power cord. Press the power button to turn on the device.

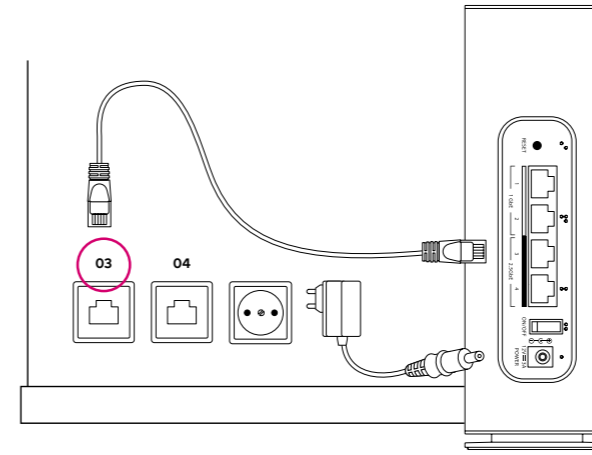

## 4. Connecting home devices

Connect your home devices to the router wirelessly (WiFi) or via an Ethernet cable (LAN).

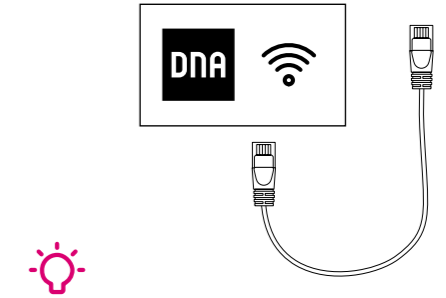

See the following pages for more detailed instructions on how to set up your device.

# 1. Choosing where to set up the router in the home

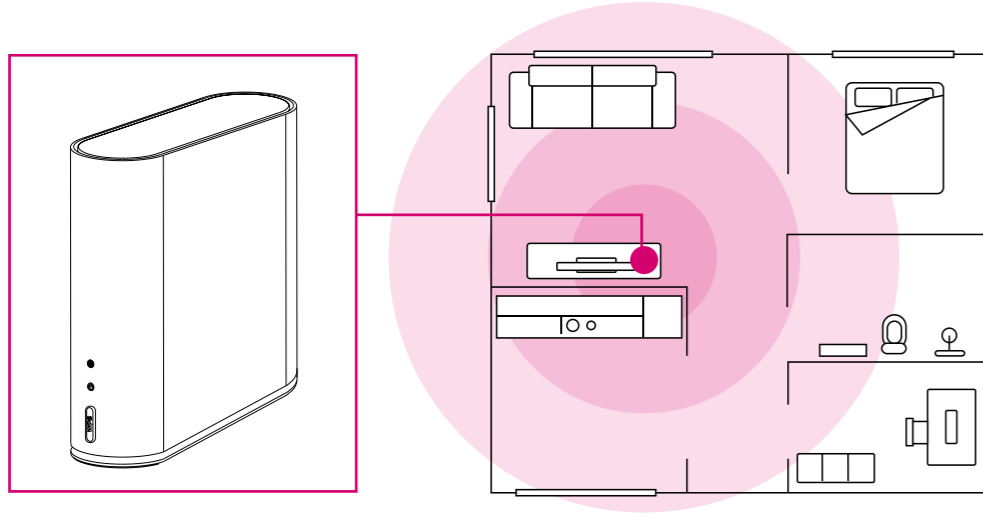

The Ethernet network is designed so that your home has a network cabinet to bring the internet into the home and one or more internet sockets in the wall.

The router is connected to one of the internet sockets. You should place the device in a central location in your home, so that you have the most reliable connection possible for all the devices connected to it.

Start by memorising the label of the internet socket (e.g. 03) in the room you have chosen to set up the router in. You will need the label for the next step.

Next, go to your home's network cabinet, which is most often situated close to the entrance.

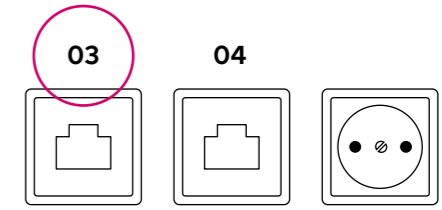

## 2. Ethernet connections in the home's network cabinet

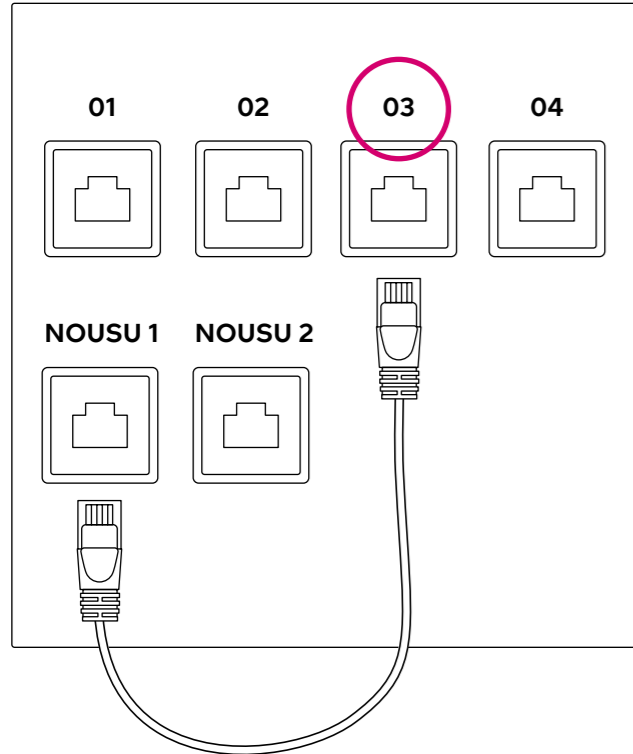

The internet in your home comes from one of the outlets in the network cabinet, labelled NOUSU, SISÄÄNTULO, ATK, A or B, for example.

Plug one end of the Ethernet cable into this outlet, and the other end into the outlet marked with the same label (e.g. 03) as the one in the internet socket in the room you chose earlier to set up your router in.

You should not set up the router in the network cabinet. Enclosed spaces will reduce the quality of your WiFi connection.

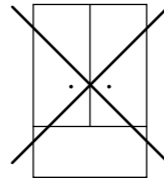

Watch a video tutorial explaining the network cabinet connections or read more at [dna.fi/tuki-reitittimet](https://dna.fi/tuki-reitittimet).

Video



Scan the code and watch the video tutorial on how to set up Ethernet.

**Need help getting started?  
Let us help!**

You can access DNA Apuri support in the chat at [dna.fi/asennusapu](https://dna.fi/asennusapu) or by calling +358 (0)44 144 044 (mobile phone charges apply) on weekdays 8:00–18:00.

### 3. Connecting and turning on the router

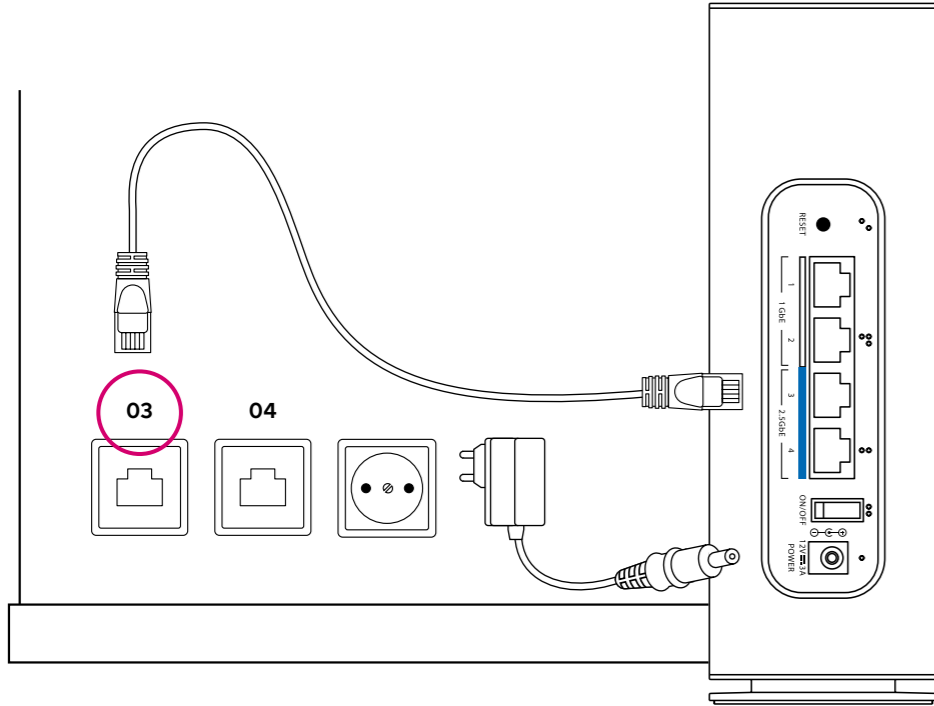



Plug one end of the Ethernet cable into the room's internet socket, and the other end primarily into one of the two blue ports on the router (the two bottom ports).

Then connect the power cord to the router and plug it into a socket.

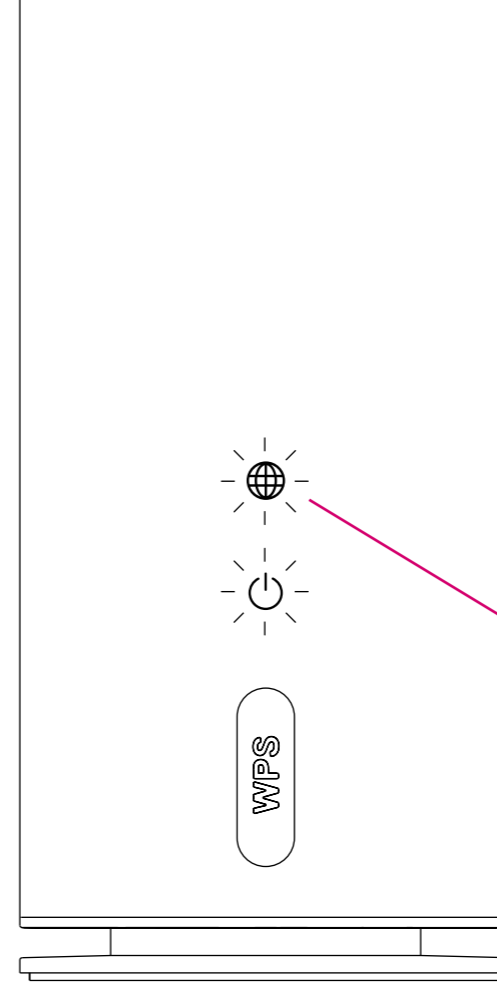

Press the power button to turn on the device.

The internet connection can also come from another device, such as an outdoor modem power supply or a fibre media converter, instead of a network cabinet and an internet socket.



   2–10 min

Wait until the internet connection is established. It usually takes a few minutes for the router to connect to the network. When the router is set up for the first time, it may take a little longer for it to connect to the network, as it may reboot itself due to a software update. The device's lights will flash while it is starting up.

-   1 Gbit/s connection
-  2.5 Gbit/s connection

The router is connected to the network when the internet indicator light (the top light) is solid yellow or green after the router has been turned on. The colour of the light indicates the type of connection the network allows; it does not indicate the speed of your connection.

For more detailed information about the indicator lights, see the last page of this guide or visit [dna.fi/tuki-reitittimet](https://dna.fi/tuki-reitittimet).

**DNA Netti is now ready to use and you can connect your device to it. Read the instructions on the next page.**

## 4 a. Connecting home devices wirelessly (WiFi)

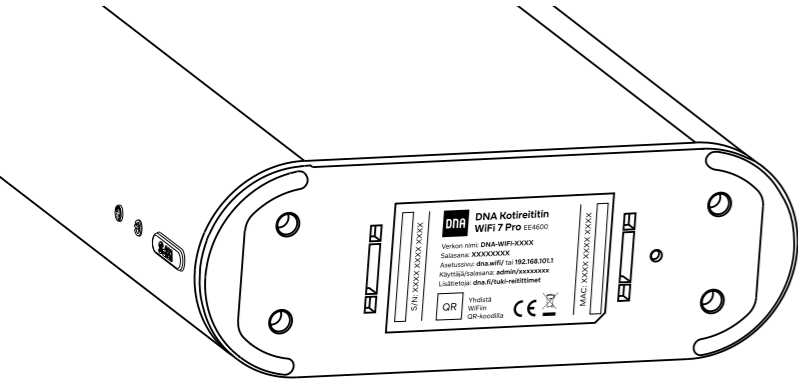

1. Open the WiFi settings on the device you want to connect (e.g. your mobile phone or computer) 
2. Select DNA-WIFI-XXXX from the list of WiFi networks.
3. Enter the password for the WiFi network.
4. You can also log in to the network by scanning a QR code.

You can find the necessary information on the label on the bottom of the device and on the router information card.

### Replacing an old router with a new one – do you need to reconnect all devices?

The easiest way to connect your existing home devices to your new router is to replace its network name and password with those of your old router. This will ensure that all devices in your home automatically connect to the new network.

## 4 b. Connecting home devices with an Ethernet cable (LAN)

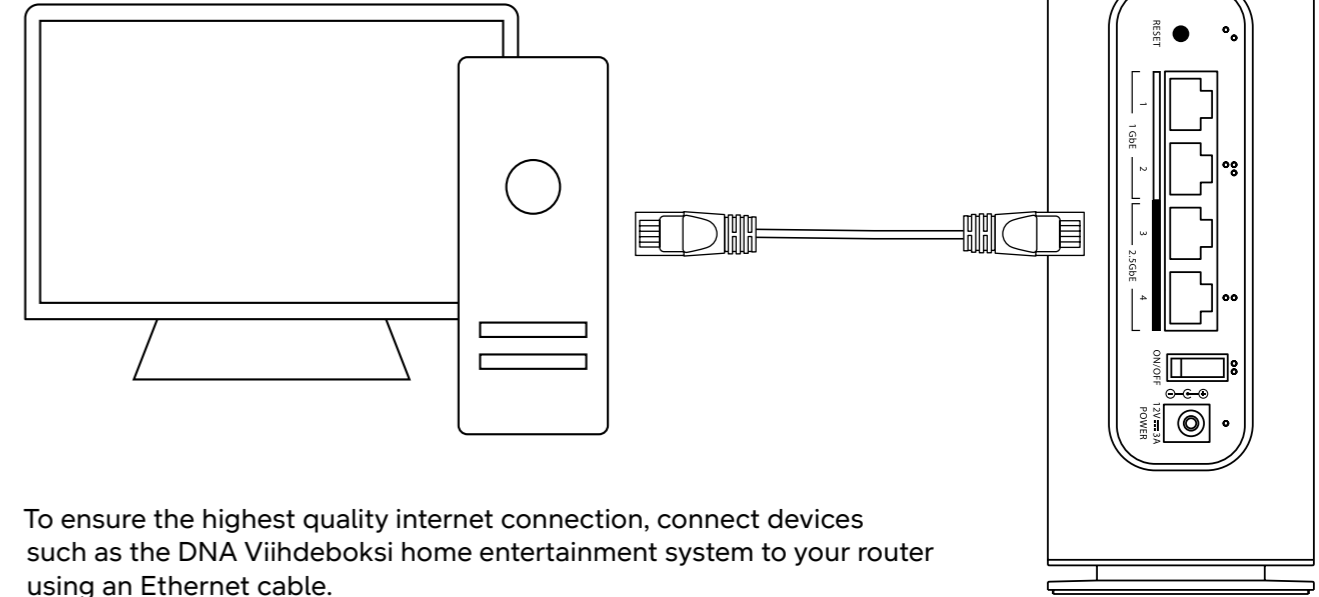

To ensure the highest quality internet connection, connect devices such as the DNA Viihdeboksi home entertainment system to your router using an Ethernet cable.

# Changing the name and passwords of the WiFi network

If you want, you can change the name and password of your WiFi network to make the login process smoother.

By configuring the WiFi details yourself, you can identify your WiFi among others and connect new devices to your home network with ease.

1. Log in to your router's configuration page at **dna.wifi/**

If the configuration page does not open, make sure your device is connected to your home router network.

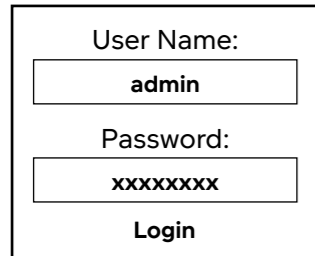

User Name:

Password:

Login

Enter 'admin' in the User Name field. You can find the password on the information card that came with the package and on the label on the bottom of the device.

2. After the first login, you can change the WiFi name and WiFi password. The default WiFi Name is the same as on the information card and the label on the bottom of the device.

Click Apply.

Once you have changed the WiFi network name and password, connect your home devices to this network.

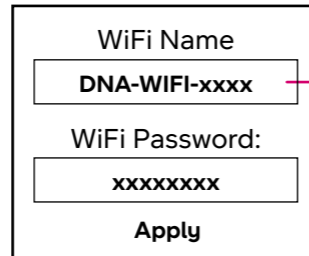

WiFi Name

WiFi Password:

Apply

Give your network a customised name



You should also change the password for the router configuration page in the process. This will further increase data security. Be sure to save the password for future reference.

Enter a password that is at least eight characters long in the **Admin Password** field and click Apply.

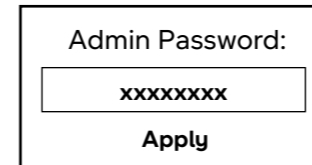

Admin Password:

Apply

For more information, see [dna.fi/tuki-reitittimet](https://dna.fi/tuki-reitittimet).

## Need help getting started? Let us help!

You can access DNA Apuri support in the chat at [dna.fi/asennusapu](https://dna.fi/asennusapu) or by calling +358 (0)44 144 044 (mobile phone charges apply) on weekdays 8:00–18:00.

## Extending WiFi coverage in the home when needed

One device (a primary router or an extender) can cover an area of around 70 square metres on one floor, provided that the signal can pass through the rooms without obstruction.

If you find that the internet is not working equally well in all rooms, you can extend the coverage of your indoor network by buying one or more extenders in addition to the primary router to build a Mesh WiFi system in your home.

You can also use the WiFi 7 Pro router as a WiFi extender. See other compatible devices for WiFi extension at [dna.fi/tuki-reitittimet](https://dna.fi/tuki-reitittimet).

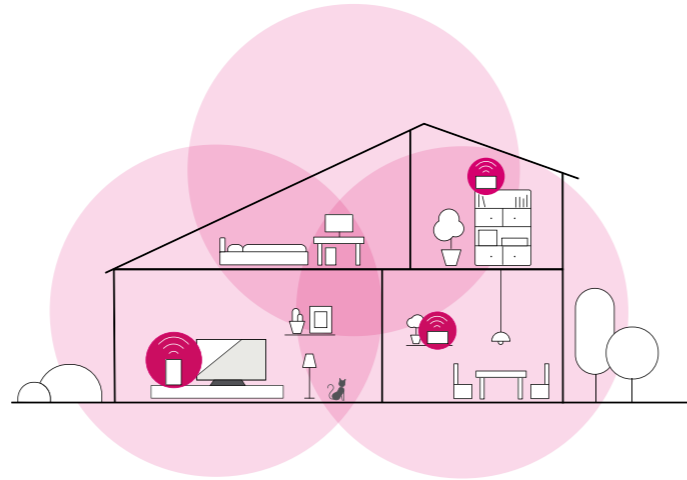

### What is the Mesh WiFi system?

Watch the video to find out how to set up a Mesh Wi-Fi network that covers your entire home.

Video



Scan the code and watch the video on Mesh WiFi.

## Watch a short **video** to make it easier to set up the WiFi extender

For video tutorials, guidance on how to manage your device settings and updated setup instructions based on user feedback, visit [dna.fi/tuki-reitittimet](https://dna.fi/tuki-reitittimet) or scan the QR code on the following page using your phone's QR code scanner (camera).

Video



Scan the code and go to the support page to watch the video tutorial on how to set up your device.

## Quick guide to setting up the WiFi extender

### 1. Connecting and turning on the extender

Connect the Ethernet cable to the primary router at one end and the extender at the other end. Plug in the power cord. Press the power button to turn on the extender.

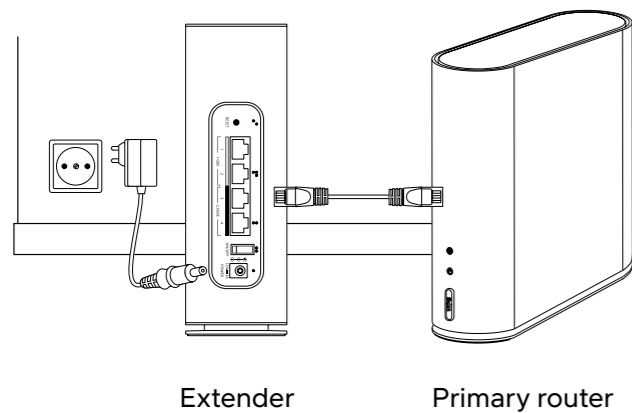

### 2. Establishing and checking the pairing connection

The devices are now paired. Check that the pairing connection is working by disconnecting the Ethernet cable from the extender. The pairing is successful when the power indicator light (the bottom light) is solid green.

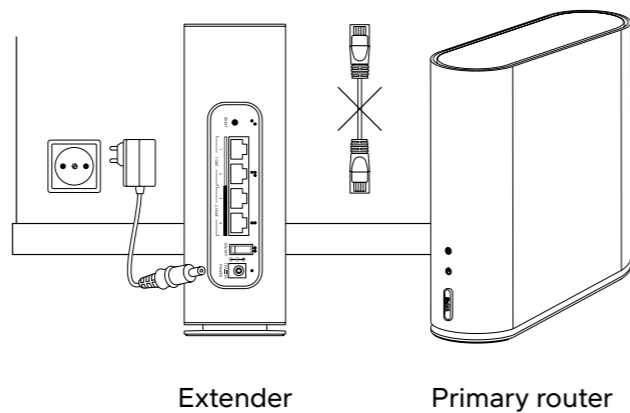

### 3. Choosing where to set up the extender in the home

Place the extender where you want the WiFi network to reach.



See the following pages for more detailed instructions on how to set up your device.

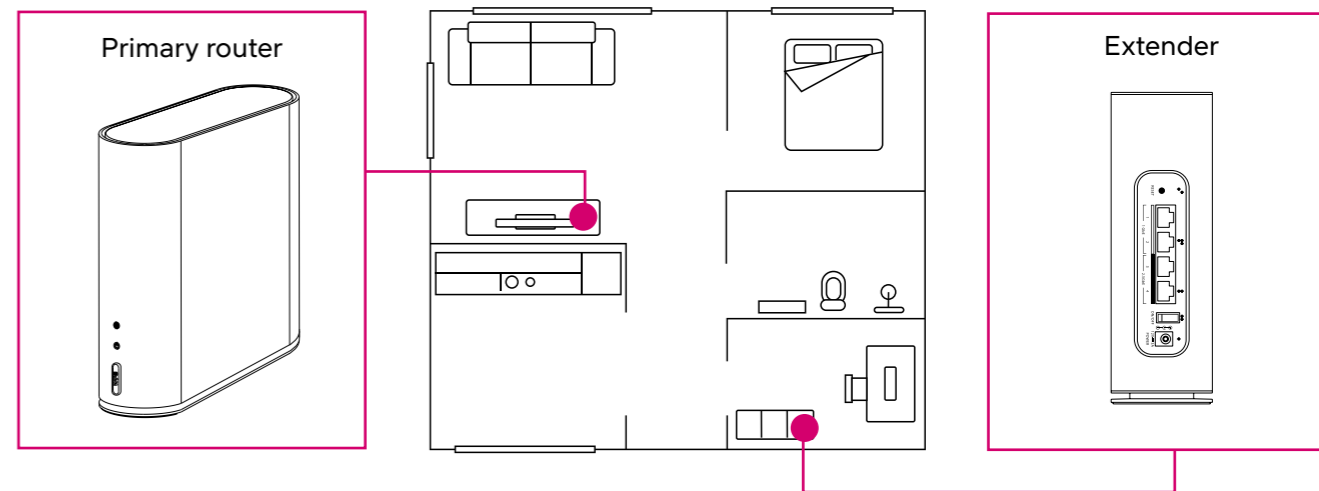

# 1. Connecting and turning on the extender

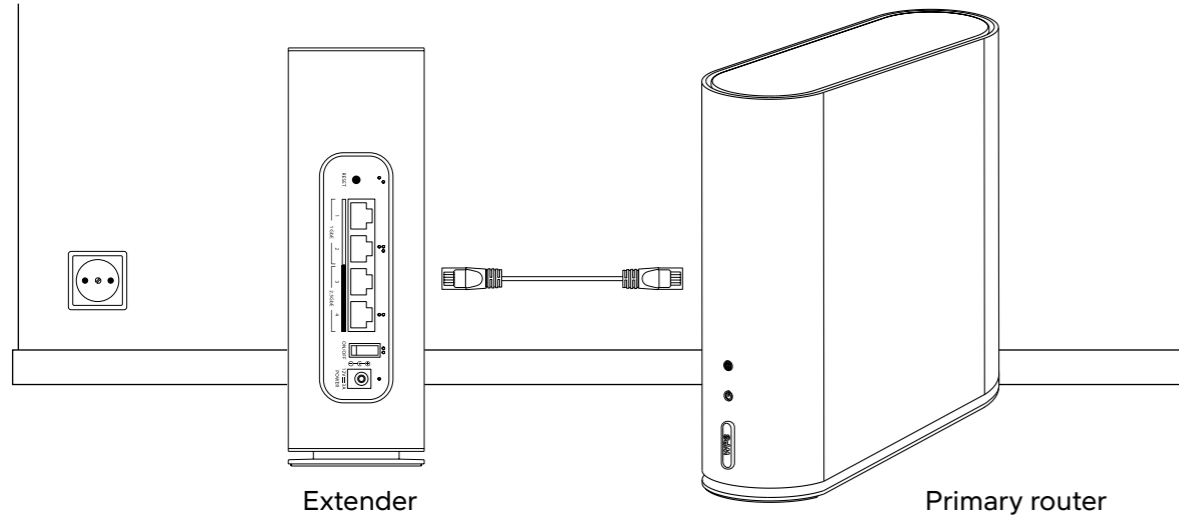

Connect the Ethernet cable between your primary router and the router you want to use as an extender. You can use any of the available Ethernet ports.

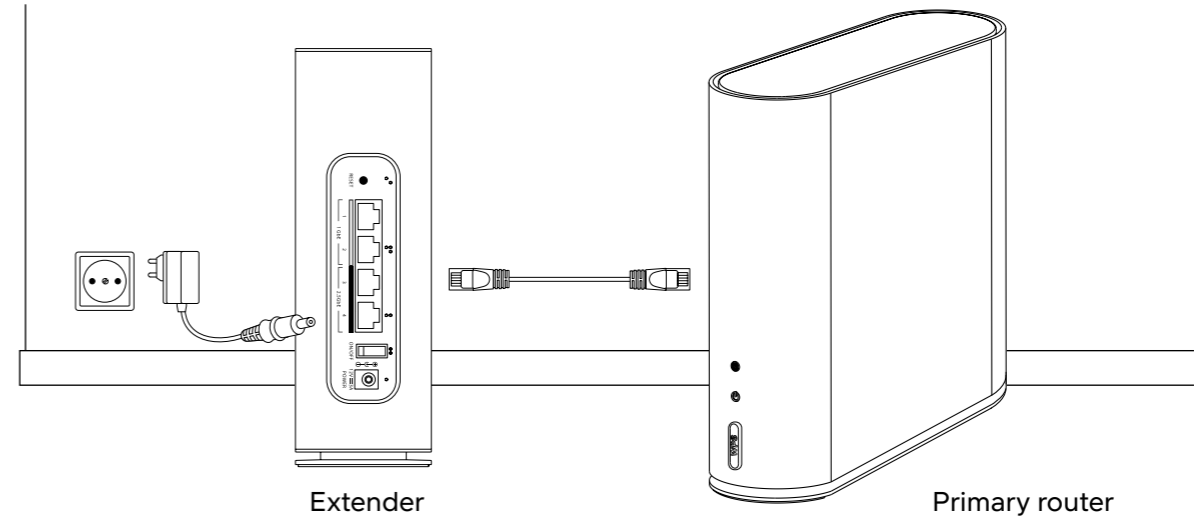

Next, plug the power cord of the extender into the wall socket and press the power button to turn on the extender.

You can also connect the devices wirelessly using the WPS button.  
Read more here: [dna.fi/tuki-reitittimet](http://dna.fi/tuki-reitittimet).

## 2.1. Pairing devices



Wait until the internet connection is established.

It usually takes a few minutes for the extender to connect to the network. When the extender is set up for the first time, it may take a little longer for it to connect to the network, as it may reboot itself due to a software update. The device's lights will flash while it is starting up.



Pairing between the devices is complete when the power indicator light (the bottom light) is solid green after it has been turned on.

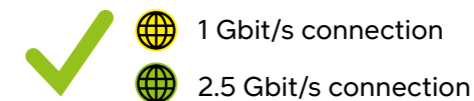
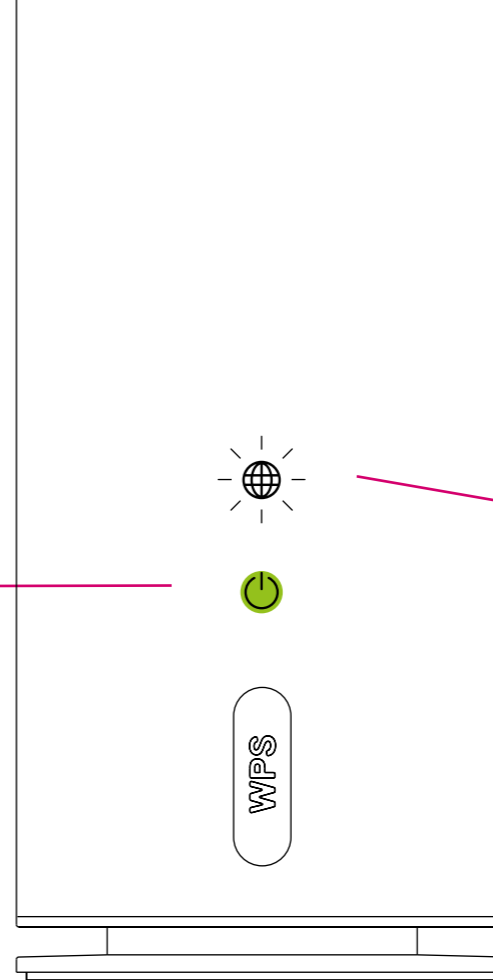

The colour of the light indicates the type of connection the network allows; it does not indicate the speed of your connection. The colour of the light is not relevant when it comes to pairing.

For more detailed information about the indicator lights, see the last page of this guide or visit [dna.fi/tuki-reitittimet](https://dna.fi/tuki-reitittimet).

Next, we will check that the pairing connection is working. ▶

## 2.2. Checking the pairing connection

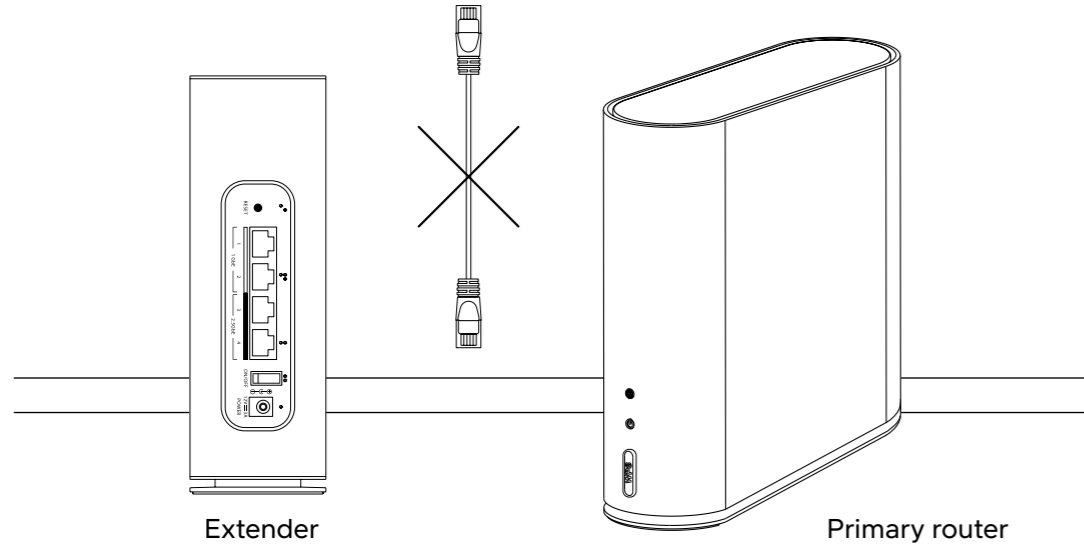

Check that the pairing connection is working by disconnecting the Ethernet cable.

- The internet indicator light (the top light) turns off and
- the power indicator light (the bottom light) changes from green to white.

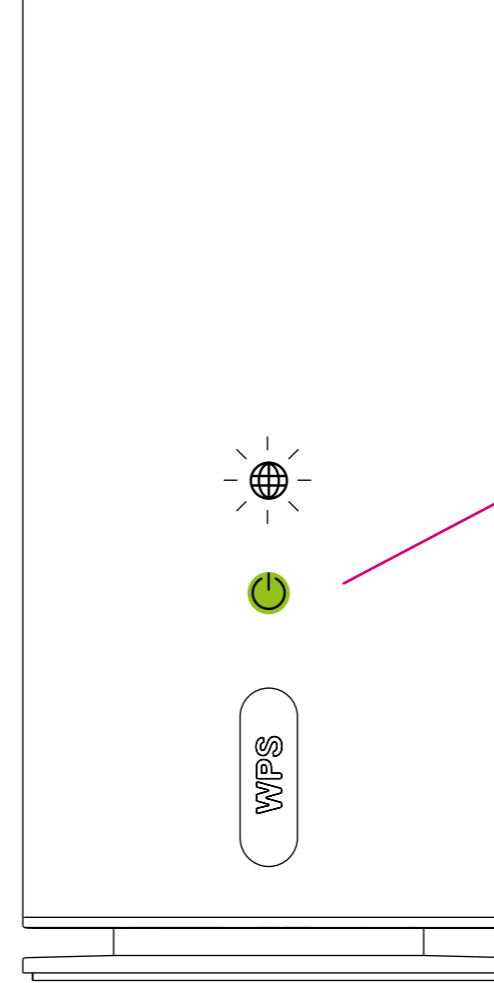

Wait a few minutes for the extender to switch to using WiFi instead of the Ethernet cable.



The pairing has been successfully re-established when the power light (the bottom light) is solid green. For more detailed information about the indicator lights, see the last page of this guide or visit [dna.fi/tuki-reitittimet](https://dna.fi/tuki-reitittimet).

The internet indicator light (the top light) now indicates the strength of the WiFi signal (see the next page for more details).

You can now move the device to the location where you want to extend your WiFi network. The devices will remain paired even if you unplug the device while you move it.

- The indicator lights on the extender will turn off
- when you move it.

### 3. Choosing where to set up the extender in the home

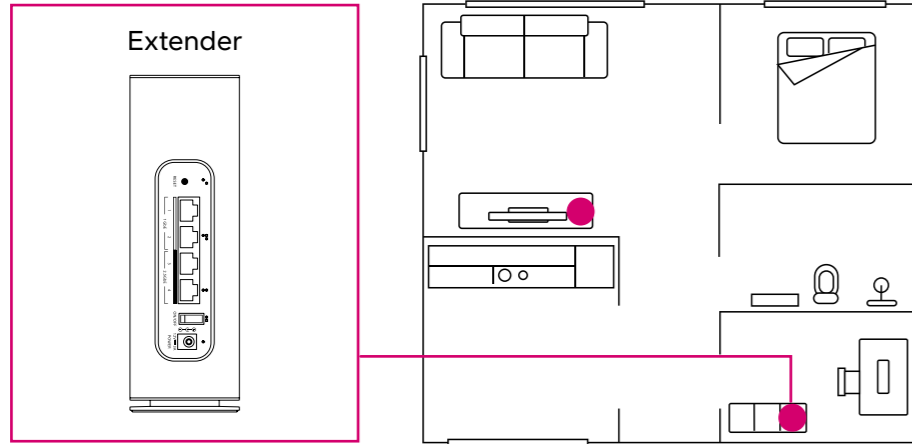

Place the extender in the most central location possible where you want to extend your Wi-Fi network. Avoid placing it on the floor or in a closed cupboard, for example.

Plug the power cord of the extender in again, this time into a socket in the room where you want to set up the extender.

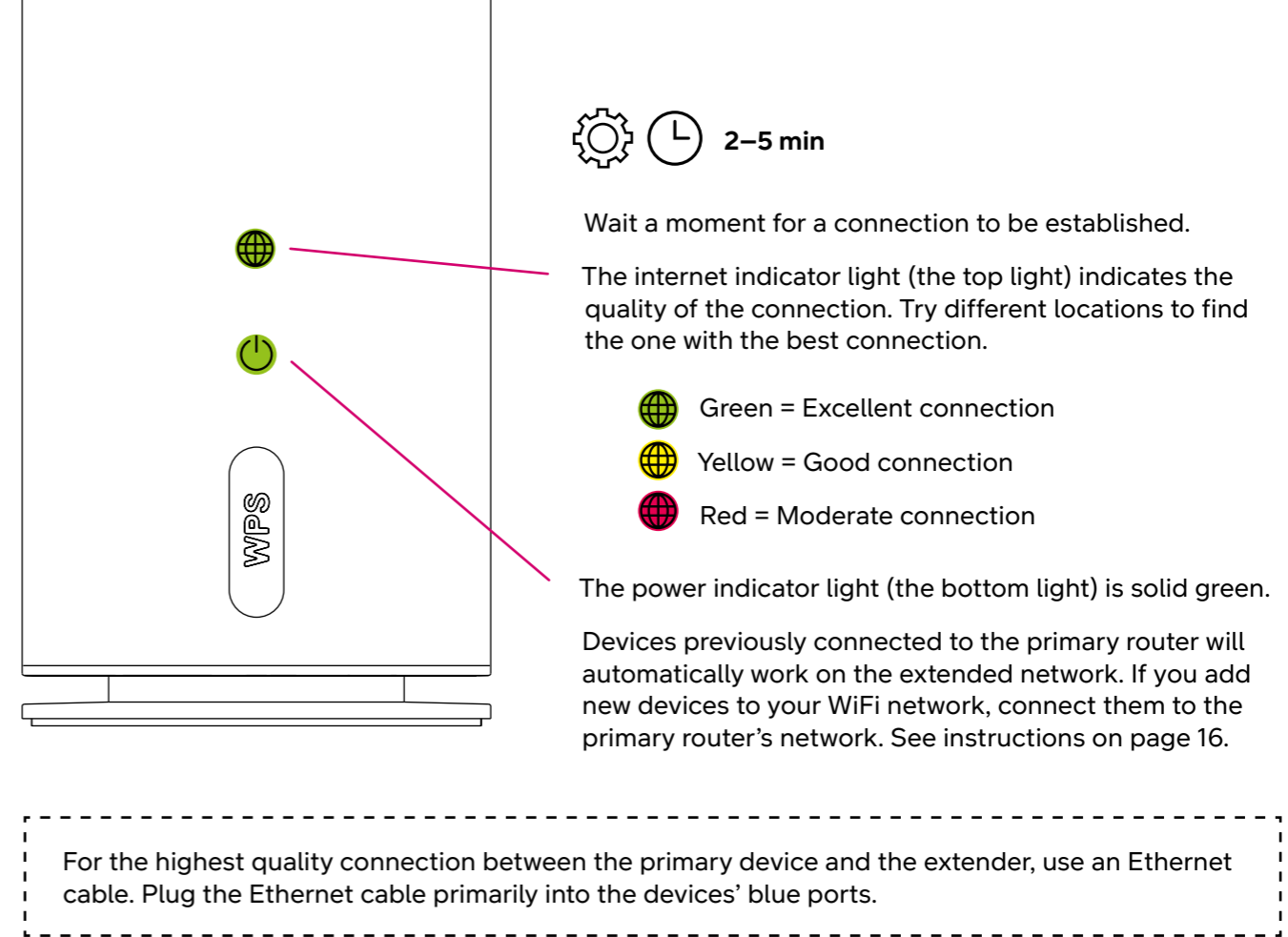

# Indicator lights explained

| Status | Meaning   |
|--------|---|
|        | Rapidly flashing white light = The device is starting up.   |
|        | Solid white light = The device is on.   |
|        | Solid green light = The device is being used as an extender (paired with the primary router).   |
|        | Slowly flashing white/green light = Software update available. Press the WPS button to start the update or leave the device waiting.        |
|        | Two yellow lights flashing slowly at the same time = Software update in progress (do not turn off the power).                               |
|        | Rapidly flashing red light = Error (try pressing the reset button on the back of the device for five seconds to reset to factory settings). |
|        | No lights = No power on the device.   |

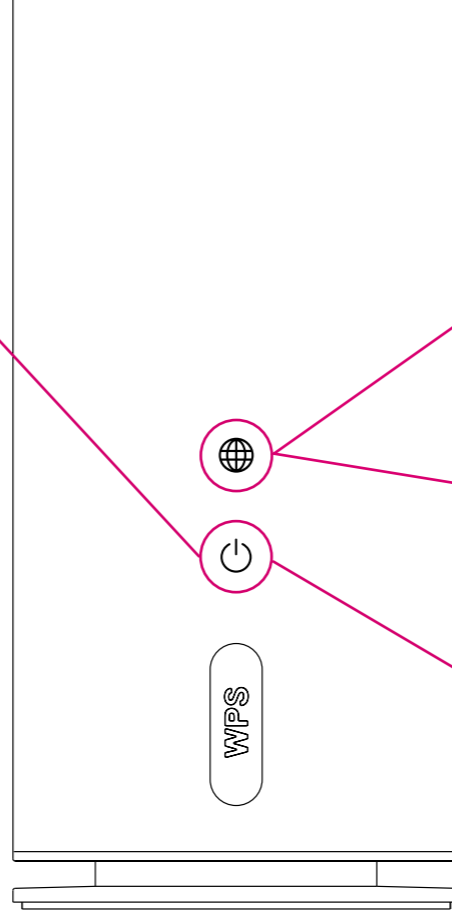

| Connected to the network via WiFi | Status | Connected to the network via an Ethernet cable* |
|-----------------------------------|--------|---|
| Excellent network connection.     |        | 2.5 Gbit/s network connection.                  |
| Good network connection.          |        | 1 Gbit/s network connection.                    |
| Moderate network connection.      |        | <1 Gbit/s network connection.                   |
| No network connection.            |        | No network connection.                          |

| Status | Meaning   |
|--------|---|
|        | Rapidly flashing green/yellow/red light = Connection to the network is being established. |
|        | No lights = No network connection.  |

| Status | Meaning   |
|--------|---|
|        | Slowly flashing yellow light = Searching for a device to pair with (WPS). |
|        | Yellow = Paired with another device (WPS).                                |

\*The colour of the internet indicator light indicates the type of connection the network allows; it does not indicate the speed of your connection.

You can turn on dark mode from the device's configuration page. Read more at [dna.fi/tuki-reitittimet](https://dna.fi/tuki-reitittimet).

## Need help getting started? Let us help!

While setting up DNA Netti is easy, configuring a router and Wi-Fi network may not be everyone's cup of tea. However, help is always near – we can even come to you if needed.

You can find our chat and more information at **[dna.fi/asennusapu](https://dna.fi/asennusapu)**  
or call **+358 (0)44 144 044** on weekdays 8:00–18:00.